

7082 259-00

LKPv 910

LIEBHERR

Disposal notes

- **Keep packaging materials away from children - polythene sheets and bags can cause suffocation!**
- Please return the packaging to an official collection point.

Your old appliance: This contains some reusable materials and should be disposed of properly - not simply with unsorted household refuse.



- Discarded appliances should be disabled: Remove the plug, cut through the connection cable and render the catch unusable so that children cannot become trapped inside.
- Ensure that the refrigerant circuit is not damaged when the appliance that is no longer needed is taken away for disposal.
- Details of the refrigerant can be found on the type plate.
- Appliances which are no longer needed must be disposed of in a professional and appropriate way, in accordance with the current local regulations and laws.

Range of appliance use

The appliance is suitable for storing and cooling laboratory preparations at temperatures of between -2°C and +16°C (LKPv 6520, 1420), 0°C and +16°C (LKPv 6522, 1422).

The appliance is **not** suitable for use in explosion-hazard areas.

For the storage of valuable or temperature-sensitive substances or products the use of an independent, constantly monitoring alarm system is necessary.

This alarm system must be designed so that each alarm status is detected immediately by an authorised person who can then take appropriate action.

Position the temperature sensor for this system in the upper part of the interior container.

Description of appliance and equipment

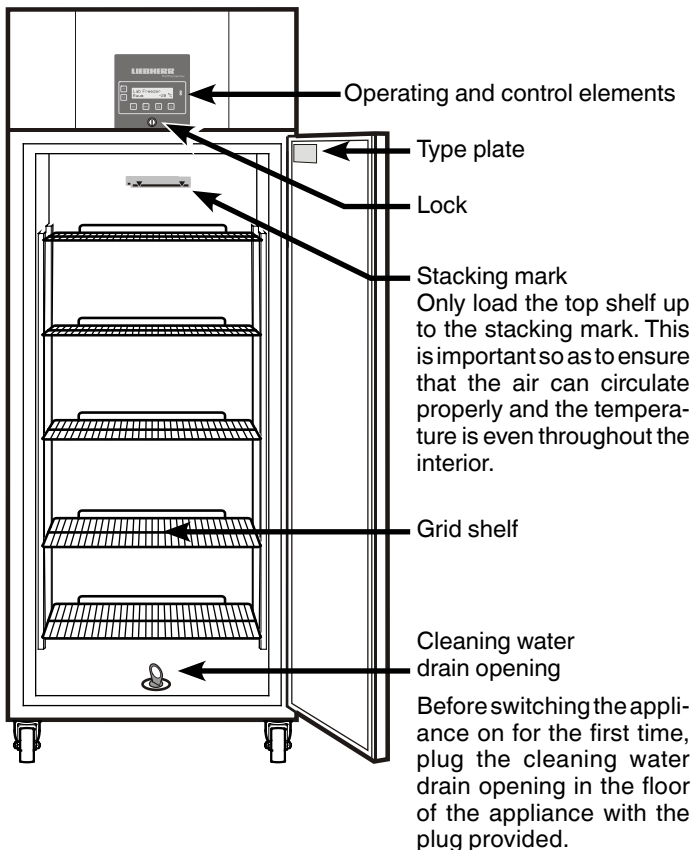

Safety instructions and warnings

- To prevent injury or damage to the unit, the appliance should be unpacked and set up by two people.
- In the event that the appliance is damaged on delivery, contact the supplier immediately before connecting to the mains.
- To guarantee safe operation, ensure that the appliance is set up and connected as described in these operating instructions.
- Disconnect the appliance from the mains if any fault occurs. Pull out the plug, switch off or remove the fuse.
- When disconnecting the appliance, pull on the plug, not on the cable.
- Any repairs and work on the appliance should only be carried out by the customer service department, as unauthorised work could prove highly dangerous for the user. The same applies to changing the mains power cable.
- Do not allow naked flames or ignition sources to enter the appliance. When transporting and cleaning the appliance ensure that the refrigerant circuit is not damaged. In the event of damage, make sure that there are no ignition sources nearby and keep the room well ventilated.
- Do not stand on the plinth, drawers or doors or use them to support anything else.
- This appliance is not intended for use by persons (including children) with reduced physical, sensory or mental capabilities or lack of experience and knowledge unless they have been given initial supervision or instruction concerning use of the appliance by a person responsible for their safety. Children should be supervised to ensure that they do not play with the appliance.
- Avoid prolonged skin contact with cold surfaces or chilled/frozen food. This could cause pain, numbness and frostbite. In the case of prolonged skin contact, protective measures should be taken, e.g. gloves should be worn.
- Do not store explosives or sprays using combustible propellants such as butane, propane, pentane etc. in the appliance. Electrical components might cause leaking gas to ignite. You may identify such sprays by the printed contents or a flame symbol.
- If you have a lockable appliance, do not keep the key near the appliance or within reach of children.
- Do not connect the appliance to the supply with other equipment using an extension cable. This can cause the extension socket to overheat.
- Do not install the appliance in the immediate vicinity of an air-conditioning unit. The appliance should also not be operated under a wall-mounted air-conditioning unit.
- The appliance is **not** suitable for storing drugs pursuant to DIN 58345.
- The appliance is **not** suitable for storing blood bottles pursuant to DIN 58371.
- In special fields of application which are subject to their own standard, the user is responsible for complying with this standard.
- The appliance is designed for use in enclosed areas. Do not operate the appliance outdoors or in areas where it is exposed to splash water or damp conditions.

Do not store any explosives or inflammable materials in the appliance.

Climate rating

The appliance is set to operate within specific ambient temperature limits according to its climate rating. These temperature limits should not be exceeded. The correct climate rating for your appliance is indicated on the type plate.

Climate rating	Ambient temperature
SN (4)	+10°C to +32°C
N (4)	+16°C to +32°C
ST (5)	+16°C to +38°C
T (5)	+16°C to +43°C

Operating and control elements

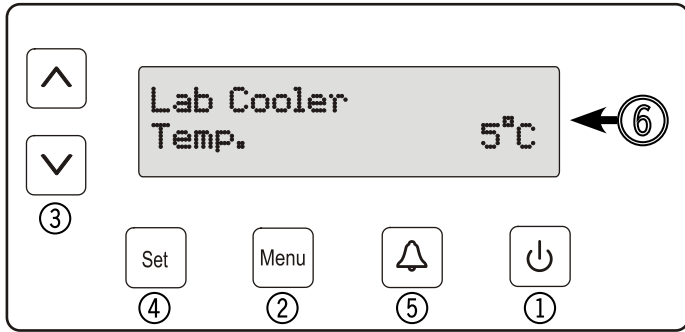

- ① **ON/OFF** button (to switch the appliance on and off)
- ② **Menu** button (to activate the main menu)
- ③ Selection buttons
- ④ **Set** button (Enter)
- ⑤ **Audible warning** on/off button
- ⑥ Display (above indication in display = standard indication)

Note: The **Menu** button can be used to cancel any unintentional actions and return to the standard indication without changing the value.

Set button

If the **Set** button is pressed in standard display mode, the date and time appear in the display.

DD/MM/YY
hh:mm:ss

Press the **Set** button again to return to the standard indication. **This is not automatic.**

Switching the appliance on and off

You are advised to clean the appliance before switching it on for the first time (see "Cleaning").

- Connect the appliance to the mains - the display reads OFF.

Switching the appliance on

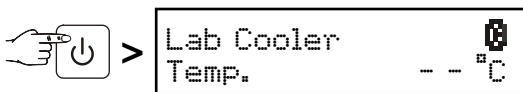

Switching the appliance off

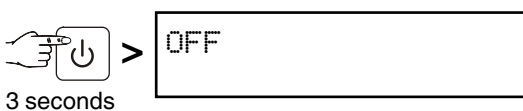

Battery charge indicator

If the symbol  appears in the display, it is necessary to check whether the battery has been connected. See section entitled **Back-up battery**.

In normal operation, the symbol also appears while the battery is being recharged.



Setting the language

Note: The preset language is **English**.

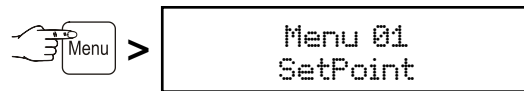

If this is the language which should remain, the following procedure is not necessary.

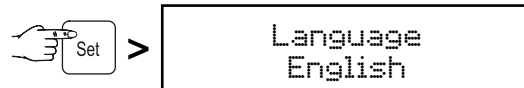
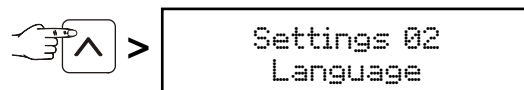
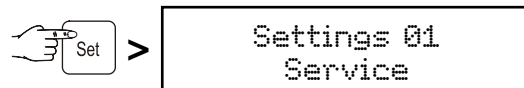
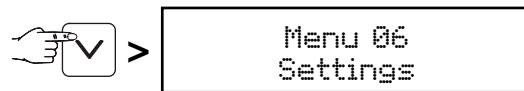

Note:

Menu 07 only appears on appliances LKPV 6522 and LKPV 1422.



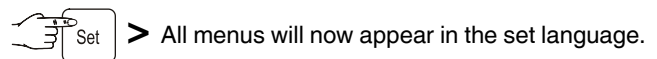

Use buttons  and  to select the desired language.



Press the **Menu** button to return to the standard indication. If no button is pressed within 60 seconds, the electronic control system switches back automatically.

Main menu

Press the **Menu** button.

Use buttons  and  to select one of the menu items.

Menu 01

Setpoint = setting the temperature

Menu 03

Defrosting = activating the defrost function manually

Menu 04

Program = preset storage programs

Menu 05

Alarm = list of alarms

Menu 06

Settings = settings on the control electronics

Menu 07 (on LKPV 6522 and LKPV 1422 only)

Light = interior light control

Menu 01 Setpoint = setting the temperature

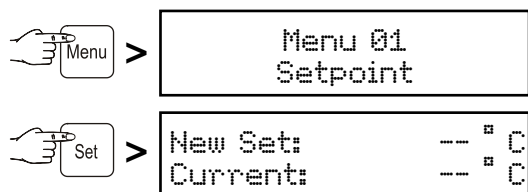

The current temperature is then shown at the bottom of the display and the required temperature is shown at the top.

Use button to reduce the temperature = colder. Use button to increase the temperature = warmer.

Press the button to accept the new setting or the button to cancel the procedure without saving.

Menu 03

Defrosting = activating the defrost function manually

The appliance defrosts automatically.

If the door has been left slightly open for a long time, a layer of ice may form in the interior and on the cooling plate. The defrost function can then be activated manually.

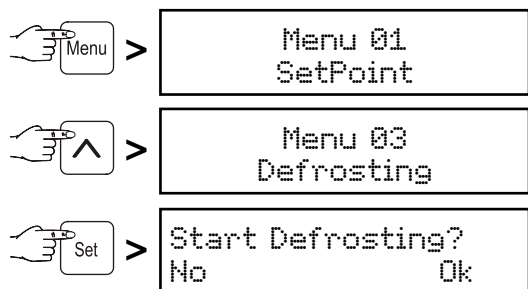

Press button to start defrosting or press the button to cancel the procedure.

Menu 04 Program = preset storage programs

If the appliance is to be used for special purposes, different storage programs can be set. The storage climate inside the appliance will then be adjusted to the intended use (temperature, humidity).

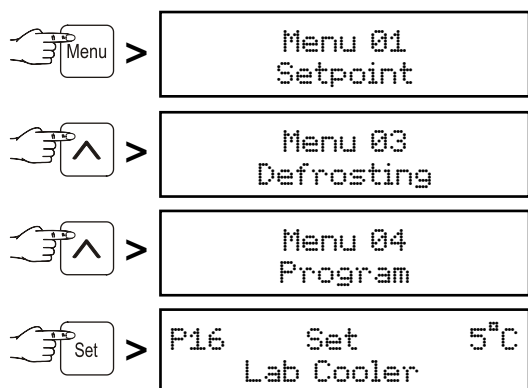

Select the desired program by pressing the buttons and .

Press the button to accept the new setting or the button to cancel the procedure without saving.

Menu 05 Alarm = list of alarms

The alarm events are saved and can be called up if required.

Thanks to an integrated battery, the electronic control system is supplied with power, even in the event of a power failure, and the alarm status is indicated immediately.

The audible warning signal sounds everytime an alarm event occurs.

The audible warning signal can be cancelled by pressing button .

The following alarm can be rectified immediately:

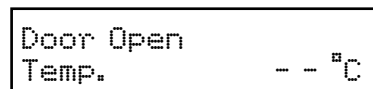

When the door is open, the above indication and the standard indication flash alternately. After 60 seconds, the audible warning signal sounds.

Cancel the audible warning signal by pressing button . Close the appliance door.

The following alarm events require the stored items to be checked:

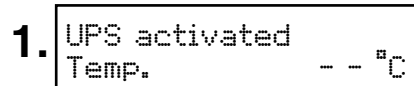

The above indication and the standard indication flash alternately.

The audible warning signal sounds.

This indication is displayed after a power failure.

Call up the length of the power failure and the maximum temperature reached inside the appliance. See chapter "**Calling up the saved alarm events**".

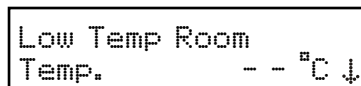
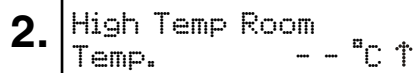

The above indication and the standard indication flash alternately.

The audible warning signal sounds.

This can be caused by:

- the appliance door being left open for a long time, allowing warm ambient air to enter;
- a long power failure;
- a fault in the appliance.

If a large quantity of warm items is placed in the appliance at once, this alarm may occur. This does not mean that there is an error.

Call up the length of the temperature rise and the maximum temperature reached inside the appliance. See chapter "**Calling up the saved alarm events**".

In both cases, the items must be checked and it must be decided if they can still be used.

All other alarms which occur must be rectified by a customer service technician.

Calling up the saved alarm events

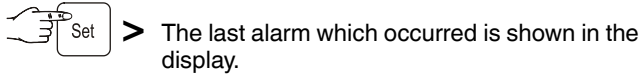
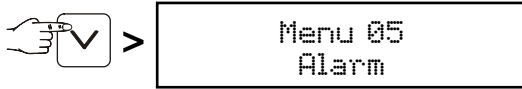
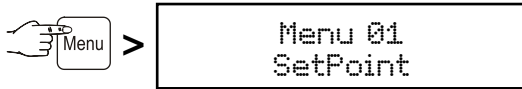

30 alarm events are saved. The highest figure (A _ _) is the last alarm which occurred. Select a previous alarm event by pressing the buttons and .

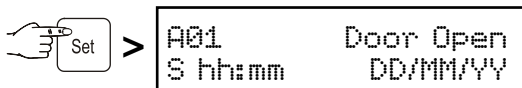

Start of the alarm event with time and date.

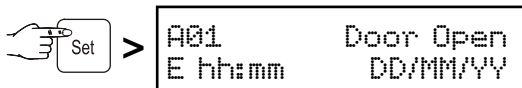

End of the alarm event with time and date.

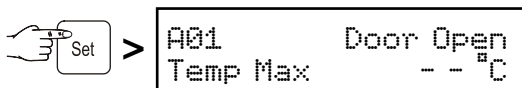

Highest temperature reached inside the appliance.

Return to the standard indication by pressing the button.

Note

After this query, the alarm display will be deleted automatically.

Menu 06 Settings

= **settings on the control electronics**

Settings 01 Service

Settings 04 Inputs/Outputs

These settings can only be carried out by the customer service department.

Settings 02 Language

Setting the display language. See paragraph "**Setting the language**".

Settings 05 Communication

This menu item is described in the documentation on the accessories set "Serial data evaluation".

Settings 03 Clock Setting

Setting the time and date.

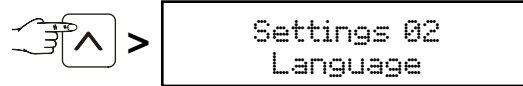
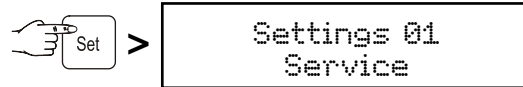
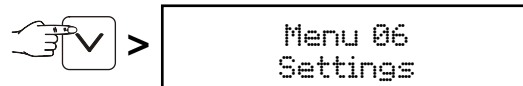
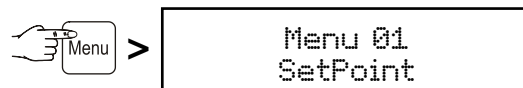

The value to be changed flashes and can be changed by pressing the buttons and .

Save by pressing the button.

Return to the standard indication by pressing the button.

The conversion from summer to winter time is **not** automatic.

Settings 06 Display

Setting for permanent display light.

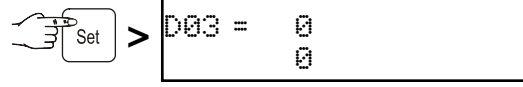
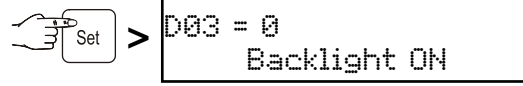
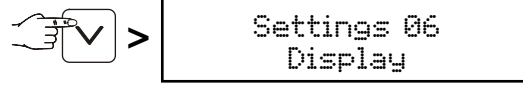
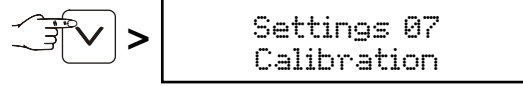
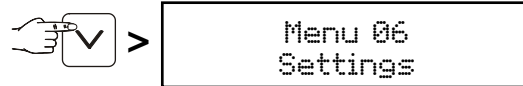
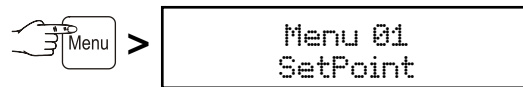

Save by pressing the button.

Return to the standard indication by pressing the button.

The display is now permanently lit.

Settings 07 Calibration

Adjustment of the displayed temperature to the actual interior temperature.

Tolerances of temperature sensors can be offset with this function.

Adjustment is possible in three temperature ranges.

CAL1 = lower temperature range (approx. -2°C)

CAL2 = middle temperature range (approx. 5°C)

CAL3 = upper temperature range (approx. 16°C)

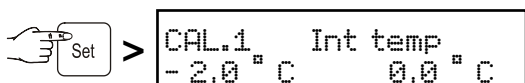
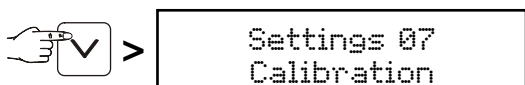
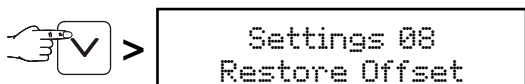
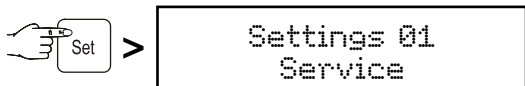
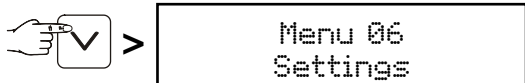
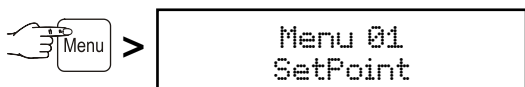

↑ °C flashes



The temperature range display flashes and can be changed using the buttons or (e.g. -1°C).

Save by pressing the button.

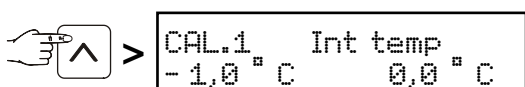

°C flashes ↑



The temperature correction value flashes and can be changed using the buttons or .

Save by pressing the button.

Use button to proceed to CAL.2 and further to CAL.3 and adjust the settings in the same way as for CAL.1.

Return to the standard indication by pressing the button.

Settings 08 Restore Offset

Setting the temperature correction values to 0.

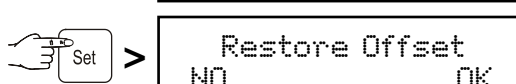
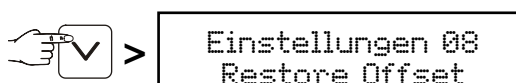
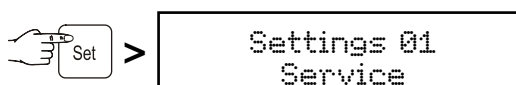
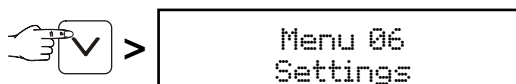
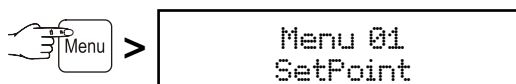

Press button to set the temperature correction values for CAL1, CAL2 and CAL3, respectively, to 0 or cancel the procedure without any changes by pressing the button.

Return to the standard indication by pressing the button.

Menu 07 Light = interior light control

Note

This function is only active on appliances LKPV6522 and LKPV 1422.

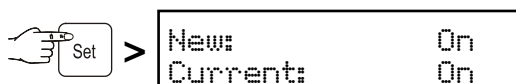
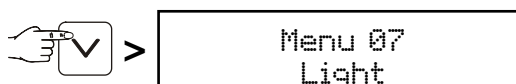
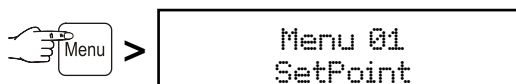

Use buttons and to select the desired setting.

On = interior light permanently lit.

Door = interior light is switched on when the door is opened and is switched off when the door is closed.

Off = interior light switched off.

Press the button to accept the new setting or the button to cancel the procedure without saving.

Keypad lock

The keypad lock ensures that no unintentional changes are made to the electronic control system.

Activating the keypad lock

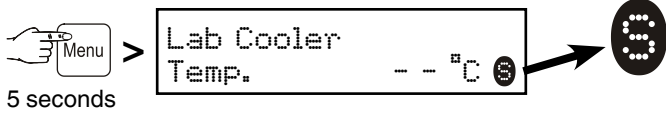

To deactivate, press again for 5 seconds.

Alarm test

To check that the alarm function is working correctly, an alarm test should be carried out at regular intervals.

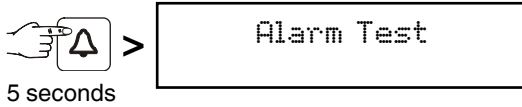

The display flashes and the audible warning signal sounds. The alarm test is terminated automatically after a few seconds.

Product sensor (available accessory)

The temperature may be measured or recorded at any point in the interior using the product sensor.

Caution!

The connection of the product sensor may only be made by trained personnel.

The appliance must be disconnected from the mains before the work is started. Remove the plug.

1. Feed the sensor through the opening in the compressor compartment and position inside the appliance.

Seal the opening with sealant.

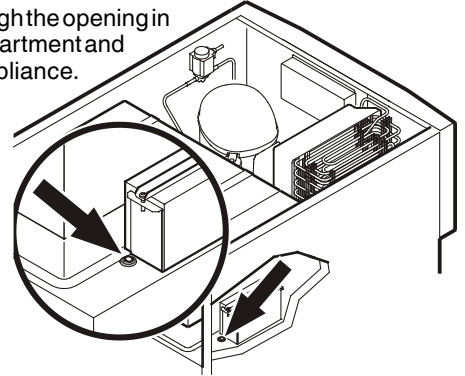

2. Undo the screw on the underside of the front panel. Tilt the front panel upwards.

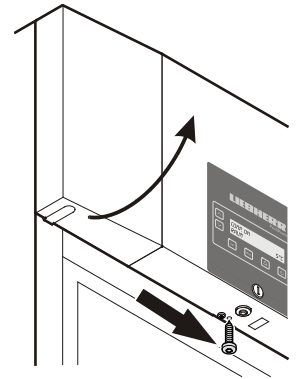

3. Plug in the product sensor plug.

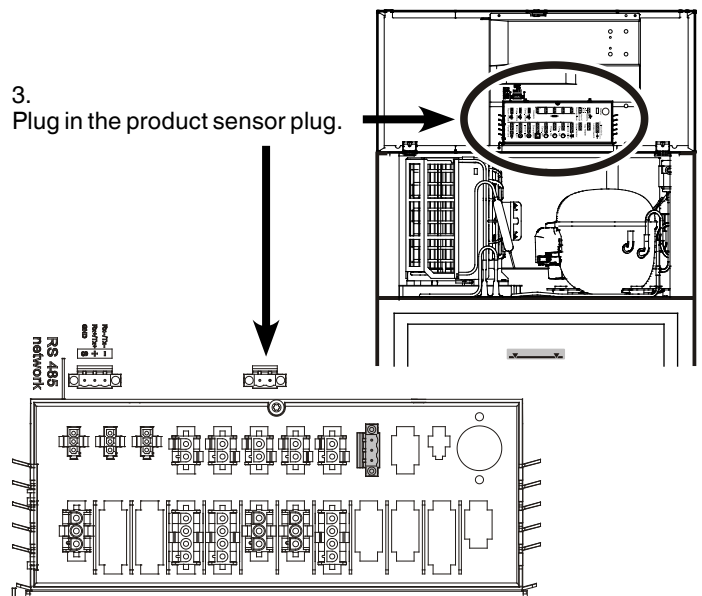

4. Close the front panel and fix with the screw.

Product sensor settings

- Connect the appliance to the mains - the display reads OFF.

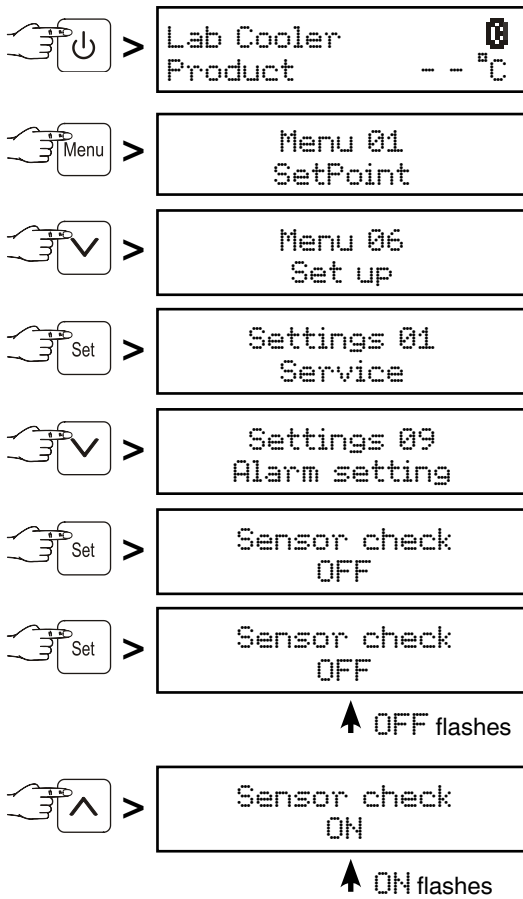

Save by pressing the **Set** button.

The sensor is now monitored by the electronic control system. In the event of a sensor error, an alarm will be signalled.

Adjusting the alarm limits



Use buttons **↓** and **↑** to select the desired setting.

Save by pressing the **Set** button.

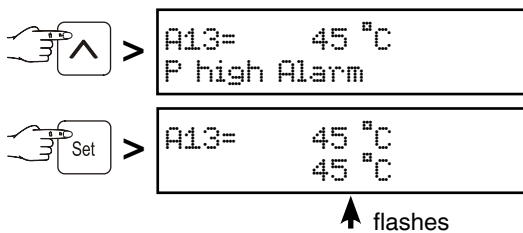

Use buttons **↓** and **↑** to select the desired setting.

Save by pressing the **Set** button.

If an alarm delay needs to be set, carry out the steps in the next section or return to the default display by pressing the **Menu** button.

Adjusting the alarm delay

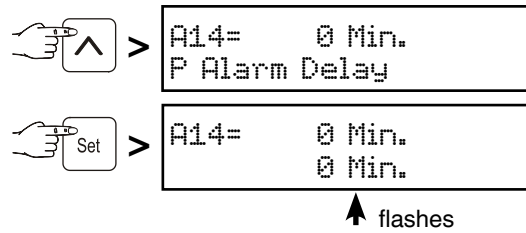

Use buttons **↓** and **↑** to select the desired setting.

Save by pressing the **Set** button.

Return to the standard indication by pressing the **Menu** button.

Note

When in standard display mode, it is possible to switch between product sensor, standard temperature sensor, both sensors and date/time using the **Set** button.

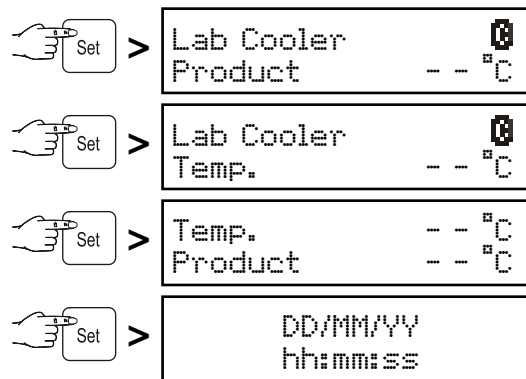

Equipment

The grid shelves are supported by shelf rails.

Depending on the height of items, the shelf rails are adjustable in 27.5 mm increments.

First slide the rails into the rear clip-in upright at the desired height and then hang in position at the front.

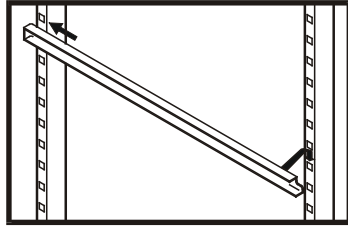

Note:

The maximum load per grid shelf is 60 kg.

Interior light on glass door appliances

The interior light is fitted on the inside at the top.

Replacing the fluorescent tube:

Pull out the mains plug or switch off or unscrew the fuse.

- Undo screw 1 on the back of the light cover.
- Push buttons 2 on the back of the cover.
- Detach the cover at the back and remove.
- Change the fluorescent tube.
- Insert the cover at the front and click into place at the back.
- Screw the screw into the cover.

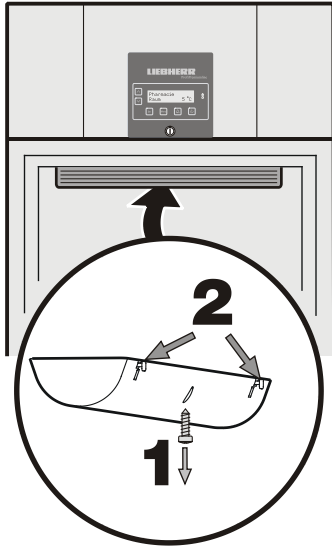

Safety lock

The lock is equipped with a safety mechanism.

Locking the appliance:

- Insert the key as shown by arrow 1.
- Turn the key 90°.

To unlock the appliance, the same procedure must be repeated in the same order.

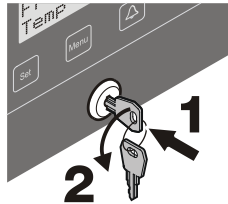

Cleaning

Before cleaning always switch off the appliance. Pull out the mains plug or switch off or unscrew the fuse.

- Transfer items to other appliances.
- Clean the inside and equipment with lukewarm water and a little detergent. Do not use abrasive or acid cleaners or chemical solvents.
- Ensure that no cleaning water penetrates into the electrical components or ventilation grille.
- Dry all parts well with a cloth.

Do not use steam cleaners because of the risk of injury and damage.

Cleaning water drain opening

A drain hose with an R 3/4 connection can be fitted to the underside of the appliance.

The water which collects in the interior during cleaning can be drained off in this way.

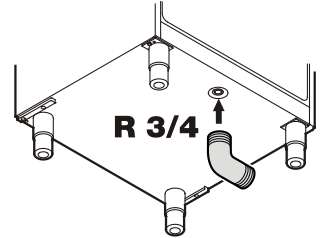

Malfunctions

You may be able to rectify the following faults by checking the possible causes yourself:

• Appliance does not function:

- Is the appliance switched on?
- Is the plug correctly fitted in the mains socket?
- Is the fuse intact?

• The temperature is not low enough:

- Is the temperature setting correct (see "Setting the temperature")?
- Have excessive amounts of fresh products been placed in the appliance?
- Does the separately installed thermometer show the correct reading?
- Is the ventilation system working properly?
- Is the appliance set up too close to a heat source?

If none of the above causes apply and you cannot rectify the fault yourself, contact the nearest customer service department stating the type designation ①, service number ② and appliance number ③ as indicated on the type plate.

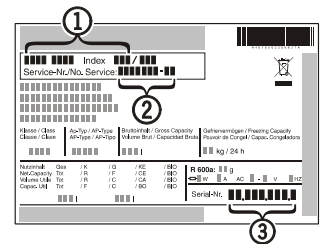

Shutting your appliance down

If your appliance is to be shut down for any length of time, switch it off and disconnect the plug or switch off or unscrew the fuse. Clean the appliance and leave the door open in order to prevent unpleasant smells.

The appliance complies with the relevant safety regulations and EC Directives 2004/108/EC and 2006/95/EC.

Changing over door hinges

Door hinges should only be changed by a trained expert.
Changing the door hinges must be done by two people.

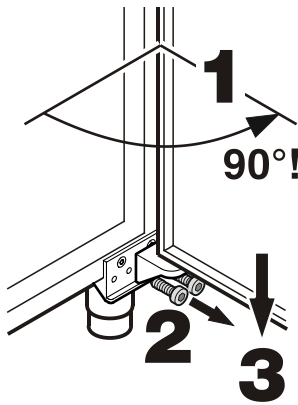

1. Open door by about 90°.
2. Remove hinge bracket.
3. Pull the door out at the bottom and lift off.

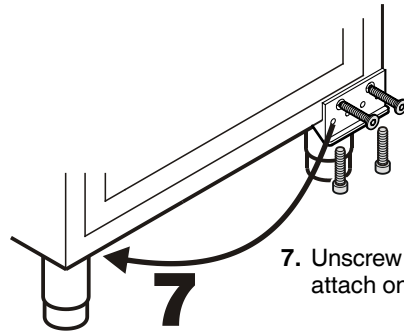

7. Unscrew base mounting bracket and attach on the other side.

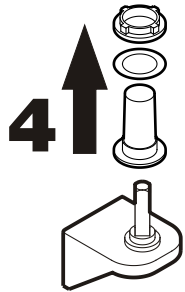

4. Remove plastic hinge bushing from hinge bracket.

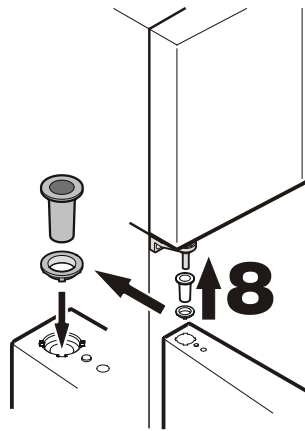

8. Keeping door open at 90°, suspend in top square pin.

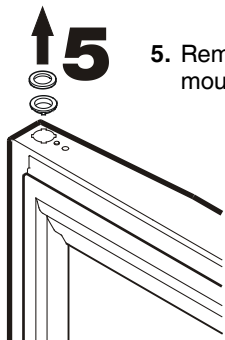

5. Remove bearing rings from upper door mounting.

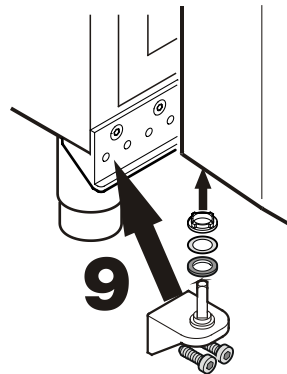

9. Insert hinge bracket in lower door mounting and screw to base mounting bracket.

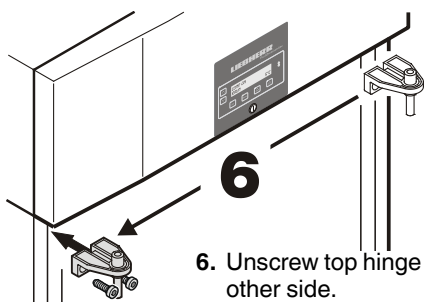

6. Unscrew top hinge bracket and attach on the other side.